

Troldtekt®

Sound absorption measurements for
35 mm Troldtekt, suspended 200 mm

VERTICAL SCHEMATIC DIAGRAM

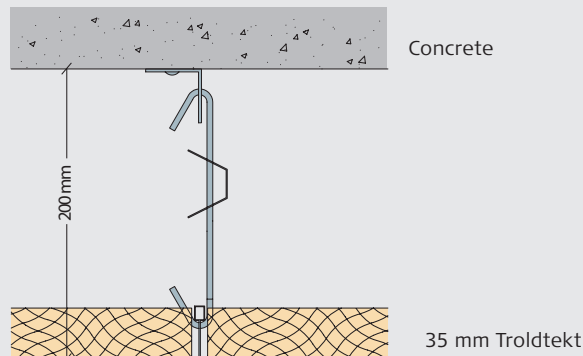

SOUND ABSORPTION MEASUREMENTS

Measurement of the sound absorption coefficients were carried out using the reverberation room method - in accordance with DS/ISO 354.

The measurements are carried out by DELTA Acoustics & Vibration A/S.

Hz	125	160	200	250	315	400	500	630	800	1000	1250	1600	2000	2500	3150	4000
α	0,17	0,23	0,25	0,31	0,38	0,41	0,40	0,36	0,30	0,28	0,38	0,44	0,44	0,50	0,58	0,70

$\alpha_w = 0,40$ - NRC = 0,35 - Absorption class D.

Absorption coefficient α

