

# INSTALLATION INSTRUCTIONS

## Troldtekt® Plus K5-F and K5-FU, installed with screws

These instructions apply to installation of Troldtekt® Plus K5-F and K5-FU with screws on wooden battens or steel profile system. If you install Troldtekt® on wooden battens, the battens should be minimum 22x95 mm. You can download installation instructions for the Troldtekt® C60 profile system or wooden battens from [www.troldtekt.com](http://www.troldtekt.com).

### PROFILE DRAWINGS (INDEPENDENT OF SUSPENSION)

KF-F and K5-FU are available as Troldtekt Plus in the following panel thicknesses: **35+18 / 35+40 mm** (Note: 35+40 mm cannot be combined with a C60 profile system)

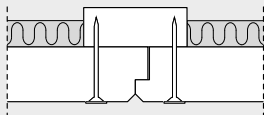

K5-F Troldtekt Plus  
With 5 mm bevel and rebate

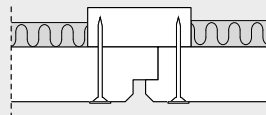

K5-FU Troldtekt Plus With 5 mm  
bevel and rebate for U-profile

### INSTALLATION (PLEASE READ FULL INSTRUCTIONS BEFORE STARTING WORK)

**1:** Start by installing a complete row of Troldtekt panels along the centre line of the room. Then continue on both sides. It is important that the panels are installed closely together, and the optimum aesthetic effect is obtained by installing the panels in broken bond.

**2:** Fix the panels using Troldtekt screws spaced 25/20 mm from the edges – as indicated in the figure below. 25 mm for wooden battens, 20 mm for C60 steel profiles. Be careful not to overdrive the washered screws and so cause an indentation in the panel.

**Note:** When installing **600x600 mm** square panels, it is important to ensure that the wood wool fibres run mainly parallel in one direction. To ensure a uniform appearance, install the panels so that the printed Troldtekt texts on the back of the panels all run in the same direction.

### ILLUSTRATION – INSTALLATION K5-F AND K5-FU

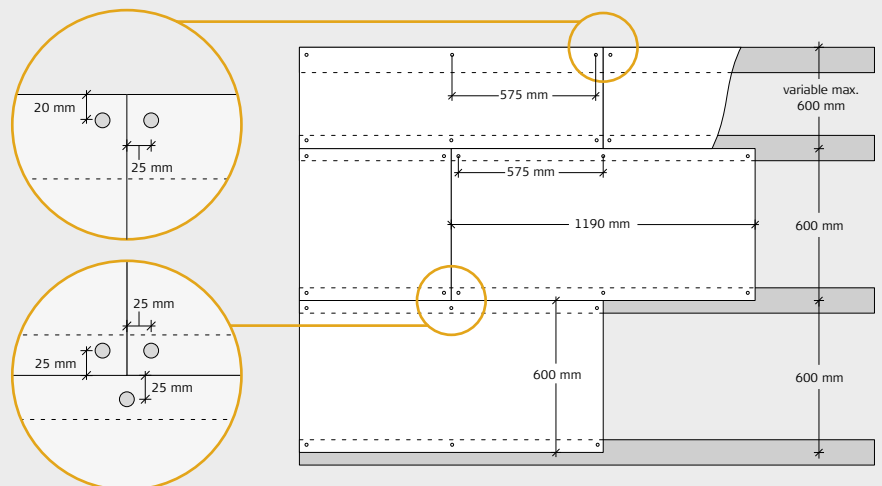

### VAPOUR CHECK

If you need to install a vapour check, we recommend using polyethylene. The vapour check must be placed over the wooden battens, i.e. between the battens and the main beam. Install the vapour check tightly against the insulation.

Please refer to the manufacturer's instructions.

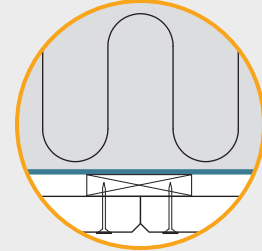

### MODULE DIMENSIONS

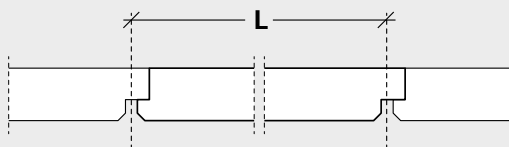

K5-FU, length (L):  
600/1190/2000/2400 mm

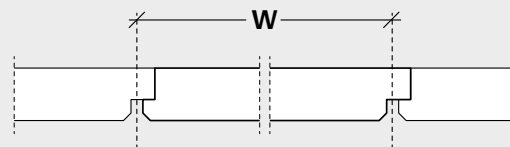

K5-FU, width (W):  
600 mm

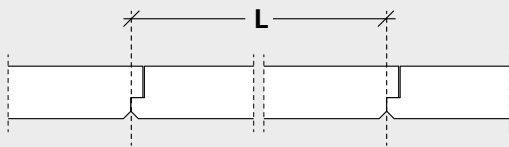

K5-F, length (L):  
600/1190/2000/2400 mm

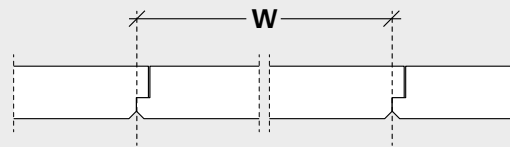

K5-F, width (W):  
600 mm

### TROLDTEKT® SCREWS

Panel thickness (mm)	Panel length (mm)	Screw dimension (mm)	No. of screws (per panel)	Max. span (mm)
35 / 35+18 / 35+40	600	4,2x45/4,2x55/4,2x50	4	600
	1190		6	
	2000/2400		10	

Troldtekt structure screw  
for wood and steel, PH2

4.2x45 mm / 4.2x55 mm



Troldtekt structure screw  
for steel, PH2

4.2x50 mm

